

Product data sheet

Characteristics

9070T150D13

Transformer, Type T, industrial control, 150 VA,
120 VAC primary / 12/24 VAC secondary, 1
phase, 50/60 Hz, 55 °C rise



Product availability: Stock - Normally stocked in distribution facility

Price*: 230.00 USD



Main

Product or component type	Industrial Control Transformer
Rated power in VA	150 VA
Range of product	T

Complementary

Phase	1 phase
Rated power in VA	150 VA
Temperature rise	55 °C
Electrical connection	Screw clamp terminals
Height	3.2 In (81.28 mm)
Width	3.75 In (95.25 mm)
Depth	3.59 In (91.19 mm)
Material	Copper winding
Product compatibility	FSC1

Environment

Product certifications	CSA file LR37055 guide 184-N-90 UL listed file E61239
NEMA degree of protection	Not rated (open device)
Insulation temperature	221 °F (105 °C)

Ordering and shipping details

Category	16200 - 9070 T (NOT TF) 50-200VA
Discount Schedule	CP8
GTIN	00785901905479
Nbr. of units in pkg.	1
Package weight(Lbs)	5.45 Lb(US) (2.472 kg)

Returnability	Yes
Country of origin	MX

Packing Units

Unit Type of Package 1	PCE
Package 1 Height	3.70 In (9.398 cm)
Package 1 width	4.30 In (10.922 cm)
Package 1 Length	4.00 In (10.16 cm)

Offer Sustainability

Sustainable offer status	Green Premium product
California proposition 65	WARNING: This product can expose you to chemicals including: Phenyl glycidyl ether, which is known to the State of California to cause cancer and birth defects or other reproductive harm. For more information go to www.P65Warnings.ca.gov
REACH Regulation	REACH Declaration
EU RoHS Directive	Compliant EU RoHS Declaration
Mercury free	Yes
RoHS exemption information	Yes
China RoHS Regulation	China RoHS Declaration
Environmental Disclosure	Product Environmental Profile
PVC free	Yes

Contractual warranty

Warranty	10 Years
----------	----------

Approximate Dimensions

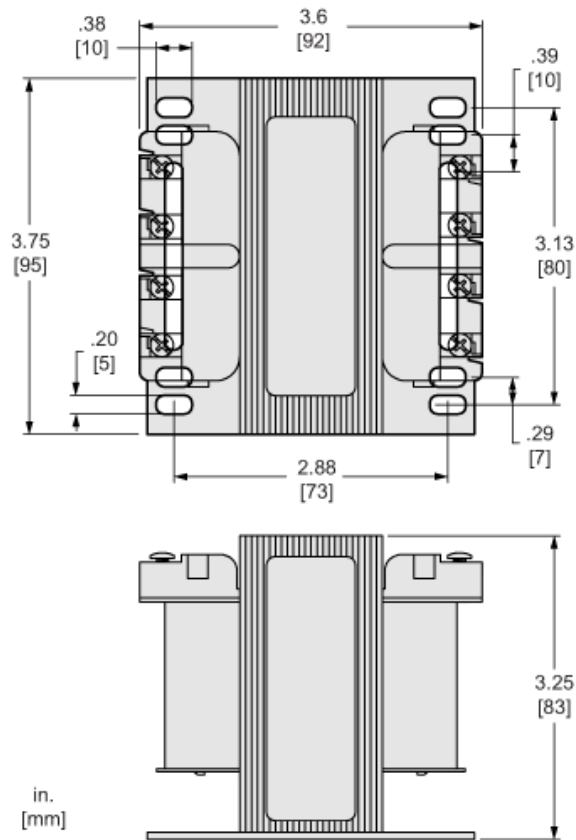

Connections and Wiring Diagrams

Voltage and Connection Options

Voltage Code	Voltages		Connections	
	Primary	Secondary	Primary	Secondary
D13	120	12/24	Connect to H1 and H2	12: Connect to X1 and X4 Jumper X1 with X3 Jumper X2 with X4 24: Connect to X1 and X4 Jumper X2 with X3
D36	600		Connect to H1 and H2	
D54	120 x 240		120: Connect to H1 and H4 Jumper H1 with H3 Jumper H2 with H4 240: Connect to H1 and H4 Jumper H2 with H3	
D59	240 x 480		240: Connect to H1 and H4 Jumper H1 with H3 Jumper H2 with H4 480: Connect to H1 and H4 Jumper H2 with H3	

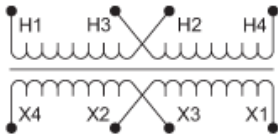
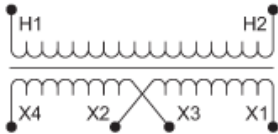

Product Life Status : **Commercialised**